

KENWOOD

FM/AM CD TUNER

KDC-9000

INSTRUCTION MANUAL

KENWOOD CORPORATION



Take the time to read through this instruction manual. Familiarity with installation and operation procedures will help you obtain the best performance from your new FM/AM CD tuner.

For your records

Record the serial number, found on the back of the unit, in the spaces designated on the warranty card, and in the space provided below. Refer to the model and serial numbers whenever you call upon your KENWOOD dealer for information or service on the product.

Model KDC-9000 Serial number _____

WARNING

▲CAUTION

The use of optical instruments with this product will increase eye hazard.

INFORMATION

This equipment generates and uses radio frequency energy and if not installed and used properly, that is, in strict accordance with the manufacturer's instructions, may cause interference to radio and television reception. It has been type tested and found to comply with the limits for a Class B computing device in accordance with the specifications in Subpart J of Part 15 of FCC Rules, which are designed to provide reasonable protection against such interference in a residential installation. However, there is no guarantee that interference will not occur in a particular installation. If this equipment does cause interference to radio or television reception, which can be determined by turning the equipment off and on, the user is encouraged to try to correct the interference by one or more of the following measures:

- Reorient the receiving antenna.
- Relocate this equipment with respect to the receiver.
- Move this equipment away from the receiver.
- Plug this equipment into a different outlet so that equipment and receiver are on different branch circuits.

If necessary, the user should consult the dealer or an experienced radio/television technician for additional suggestions. The user may find the following booklet prepared by the Federal Communications Commission helpful:

"How to Identify and Resolve Radio-TV Interference Problems".

This booklet is available from the U.S. Government Printing Office, Washington, DC 20402, Stock No. 004-000-00345-4.

- AS the laser beam used in this compact disc player is harmful to the eyes, do not attempt to disassemble the cabinet. Refer servicing to qualified personnel only.

FCC WARNING

This equipment may generate or use radio frequency energy. Changes or modifications to this equipment may cause harmful interference unless the modifications are expressly approved in the instruction manual. The user could lose the authority to operate this equipment if an unauthorized change or modification is made.

NOTE

This equipment has been tested and found to comply with the limits for a Class B digital device, pursuant to Part 15 of the FCC Rules. These limits are designed to provide reasonable protection against harmful interference in a residential installation. This equipment may cause harmful interference to radio communications, if it is not installed and used in accordance with the instructions. However, there is no guarantee that interference will not occur in a particular installation. If this equipment does cause harmful interference to radio or television reception, which can be determined by turning the equipment off and on, the user is encouraged to try to correct the interference by one or more of the following measures:

- Reorient or relocate the receiving antenna.
- Increase the separation between the equipment and receiver.
- Connect the equipment into an outlet on a circuit different from that to which the receiver is connected.
- Consult the dealer or an experienced radio/TV technician for help.

SAFETY PRECAUTIONS

▲WARNING

To prevent fire and avoid personal injury in case of accidents

- Make sure the faceplate is securely locked in place.
- When extending the power supply, memory backup or ground lead, avoid short circuits by using 0.75mm² (AWG 18) or larger automotive grade cable.
- Check to be sure that no metal objects (tools, needles, coins) are left inside the unit.
- If you smell or see smoke, disconnect the unit immediately and consult your KENWOOD dealer. Continued use can cause a fire or permanent damage to the unit.

▲CAUTION

To keep the unit in proper working order

- Be sure it's connected to a 12V DC power supply with a minus ground connection.
- Do not open front panel or top or bottom cover.
- Do not expose this unit to direct sunlight or high heat.
- Keep it clean and dry.
- Be sure it is fastened securely and not exposed to excess vibration.
- Do not leave the remote control unit in high temperature such as from direct sunlight. It results in the deformation of the case.

▲CAUTION

This unit is equipped with a theft deterrent faceplate. To prevent damage to the faceplate and case

- Avoid exposure to direct sunlight and heat. High temperatures can cause deformation and warping.
- Avoid exposure to water.
- The faceplate is a high-precision instrument. When the faceplate is detached, store it in its special case. Never drop it or subject it to other shocks.
- Do not touch the faceplate terminal or faceplate mount with your fingers.

NOTE

- If you have difficulty in installing this unit in your vehicle, please contact your KENWOOD dealer.
- If it doesn't seem to be working properly, first press the Reset button. If the malfunction persists, consult your KENWOOD dealer.



Reset button

CARE AND MAINTENANCE

Cleaning

1. Always turn the power OFF before cleaning.
2. Wipe the front panel and other exterior surfaces with a soft dry cloth or a soft cloth lightly moistened with a neutral detergent.

▲CAUTION

- DO NOT use abrasive pads or paint thinner, benzene, or other volatile solvents. These may remove the indicator characters.

CD slot cleaning

Since dust accumulates in the CD slot, it will sometimes need to be cleaned. Discs loaded in dusty slots may be damaged.

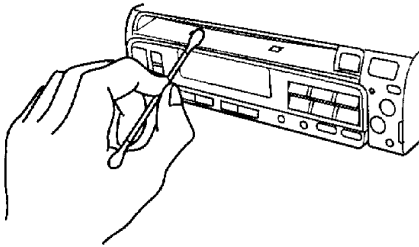

Cleaning the faceplate terminal

If the faceplate terminal or faceplate mount terminal become dirty, wipe them clean with a soft, dry cloth.

Replacing battery of remote control unit

- The battery life is approximately a half year. When the life has expired, please replace the battery with a new battery.
- The remote control unit uses a lithium battery (CR2025).
- Insert battery following the illustration inside the battery box, taking care not to reverse the ⊕ and ⊖ polarity.

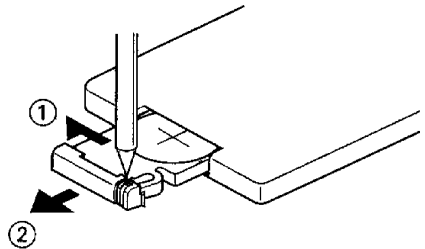

LENS FOGGING AND HEAT PROTECTION

Lens Fogging

- In cold climates, there may be a period after you turn on your vehicle's heater when the lens that guides the laser beam used in your CD player fogs up. If this happens, your CD player will not work properly. If you wait about an hour, the fogging will disappear and your CD player will work normally. If it does not return to normal, please contact your KENWOOD dealer or authorized service center.

Heat Protection

- In warm climates, when vehicles are left standing in direct sunlight with the windows closed, the temperature inside can rise above 60°C. Your CD player's protection circuits will then display the message "HOLD" and prevent the player from operating. Just open the windows or turn on the air conditioning. As soon as the "HOLD" message disappears, the player will operate normally. If it does not return to normal, press Reset button before use.

HANDLING COMPACT DISCS

- Stains, dust, scratches or warping can cause skipping or other malfunctions. To enjoy your discs for a long time, please handle them as follows.

<Holding a Disc>



- Avoid touching the music storage area (the part with the glistening rainbow colors).

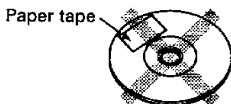

- Do not use paper tape on the label or music storage area.

<Storing Your Discs>

- Do not store discs where they will be exposed to direct sunlight, high heat, or humidity.
- Especially in summer, never leave your discs exposed to sunlight on the dashboard or on the seat with the windows closed. High heat can cause warping.
- If you do not use your player for an extended period of time, remove the disc magazine from the changer and store it in a cool, dry place.
- Store your discs in their cases or in the magazine. To avoid scratches, dirt, or warping, do not leave them lying around without cases, piled up, or leaning on each other.

<Cleaning Your Discs>

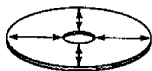

- If there are fingerprints or stains on a disc, wipe them off with a soft cotton cloth, wiping from the center to the outside edge. Never use paint thinner, benzene or conventional record cleaners.

<Check Your New Discs>

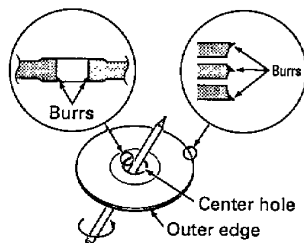

- Some new discs have burrs on their outer edges or around the hole in the center. Use a ballpoint pen or similar instrument to remove them. Discs with burrs may not fit properly in the player or disc magazine, causing skipping when they are played.

<Disc Accessories>

- There are several types of stabilizers, protective seals, and other disc accessories on the market, which claim to offer improved sound quality or disc protection. These accessories can, however, change the dimensions or thickness of a disk and may cause the disc changer to malfunction. They should not be used on discs played in this unit.

	Page
■ Before you begin	
FEATURES	8
■ Your new CD Tuner	
ON/OFF, ALL MODE STANDBY & VOLUME CONTROLS	11
INTENSITY.....	12
AUTO SEEK TUNING	13
MANUAL TUNING.....	14
LOCAL SCAN AND MONAURAL TUNING.....	15
TO PLAY COMPACT DISCS.....	16
USING THE REMOTE CONTROL.....	18
■ Tuner features	
PRESET STATIONS.....	19
AUTO MEMORY	20
PRESET SEEK	21
PRIORITY PRESET	22
DIRECT ACCESS TUNING.....	23
■ CD player features	
TRACK SEARCH.....	24
TRACK REPEAT.....	25
TRACK SCAN	26
RANDOM PLAY	27
DIRECT TRACK SEARCH	28
■ CD changer features	
TO PLAY COMPACT DISCS.....	29
TRACK/DISC SEARCH.....	30
TRACK/DISC REPEAT	31
TRACK SCAN	32
DISC SCAN.....	33
RANDOM PLAY	34
MAGAZINE RANDOM PLAY.....	35
MEMORY PLAY.....	36
DIRECT TRACK/DISC SEARCH.....	38
■ Convenient features	
CLOCK DISPLAYS/SETTING	39
AUDIO CONTROLS.....	40
PRESET TONE.....	42
SELECTABLE ILLUMINATION	44
SELECTABLE DISPLAY TYPE	45
PHONE INTERFACE.....	46
THEFT DETERRENT FACEPLATE	47
CHANNEL BAND SELECTION	48
■ Installation	
ACCESSORIES.....	49
INSTALLATION PROCEDURE.....	50
CONNECTIONS.....	51
INSTALLATION	52
■ Troubleshooting guide	54
■ Specifications	56

FEATURES

■ TUNER FEATURES

- **Auto seek tuning (p.13)**
Automatically searches for stations you can receive.
- **Local scan (p.15)**
When this feature is turned on, it combines scanning and Auto Memory and presets only strong stations offering good reception.
- **Monaural tuning (p.15)**
When stereo reception conditions are poor, turning on this function switches reception to monaural, improving sound quality by reducing noise.
- **Preset stations (p.19)**
Stores the frequencies of your favorite stations in memory, for one-touch tuning.
- **Auto memory (p.20)**
Automatically stores the strongest stations you can pick up, for one-touch tuning.
- **Preset seek (p.21)**
Receives stations which have been stored in memory in order.
- **Priority preset (p.22)**
This feature allows instant one-touch access to a station you often listen to (for news, traffic information, etc.), regardless of your tuner's operating mode.
- **Direct access tuning (p.23)**
This remote control feature allows you to input a frequency to listen to that station of your choice.

■ CD PLAYER FEATURES

- **Track repeat (p.25)**
Plays the same track repeatedly.
- **Track scan (p.26)**
Automatically plays the first part of each track on the disc in sequence, to help you find the one you want.
- **Random play (p.27)**
Plays the tracks on a CD in random order.
- **Direct track search (p.28)**
This remote control feature allows you to enter the number of the track you wish to hear by pressing the appropriate number keys.

■ CD AUTO CHANGER FEATURES

- **CD auto changer control (p.29-38)**
Controls operations of the CD auto changer.
- **Track repeat (p.31)**
Plays the same track repeatedly.
- **Disc repeat (p.31)**
Plays the same disc repeatedly.
- **Track scan (p.32)**
Automatically plays the first part of each track on the disc in sequence, to help you find the one you want.
- **Disc scan (p.33)**
Automatically plays the first part of each disc in the CD auto changer, to help you find the one you want. Especially helpful when you cannot remember the number of the disc you want.
- **Random play (p.34)**
Plays the tracks on a CD in random order.
- **Magazine random play (p.35)**
Plays discs and tracks of discs in your auto changer in random order.
- **Memory play (p.36)**
Selects 20 tracks from a disc magazine and stores them in memory. The stored tracks can be played in the order they were stored in memory.
- **Direct track/disc search (p.38)**
This remote control feature allows you to enter the number of the track or disc you wish to hear by pressing the appropriate number keys.

FEATURES

■ CONVENIENT FEATURES

- **Remote control (p.18)**
This unit can be operated using the wireless remote control supplied as an accessory. Some features require the remote control.
- **Clock display (p.39)**
Displays the time in the display window.
- **Preset tone (p.42)**
Adjusts the tone controls (bass, mid-bass and treble) and stores their settings in the memory. The stored tones can be recalled with a one-touch operation.
- **Selectable illumination (p.44)**
Allows illumination color to be switched between green and orange.
- **Selectable display type (p.45)**
Lets you change the display from negative to positive or vice-versa.
- **Phone interface (p.46)**
Pauses the player automatically whenever a call is received.
- **Theft deterrent faceplate (p.47)**
When you leave the vehicle, you can take the faceplate with you, to help prevent theft.
- **Channel band selection (p.48)**
Allows you to switch bands between FM:200kHz/AM:10kHz and FM:50kHz/AM:9kHz.
- **Automatic illumination**
Causes the display panel to light up when the vehicle's lights are on.

ON/OFF, ALL MODE STANDBY & VOLUME CONTROLS

POWER ON/OFF

To turn the power ON

- ▶ Press the Power button.

To turn the power OFF

- ▶ Press the Power button for more than one second.

ALL MODE STANDBY

In tuner mode, briefly pressing the Power button puts the unit in All mode standby, waiting for a new mode selection.

OFF

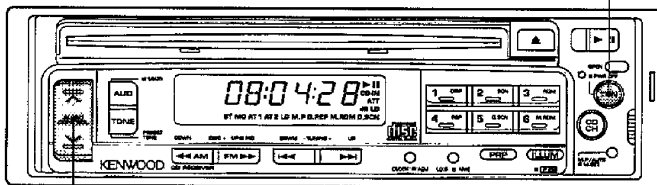

VOLUME

To increase the volume

- ▶ Press the \blacktriangle button.

To lower the volume

- ▶ Press the \blacktriangledown button.

(The display indicates the sound level in decibels (dB).)

VOL -28 dB

NOTE

- Turning the power ON automatically restores the settings in use when the unit was turned OFF.
- Perform these operations with the power ON.

INTENSITY



- ▶ If the Loud indicator light is not illuminated, press the Loud button for more than one second. (Loud indicator light will light up. Both bass and treble volume increase.)

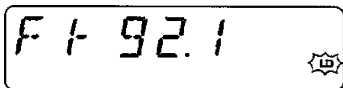

TO RESTORE ORIGINAL LEVELS

- ▶ Press the Loud button again for more than one second. (Loud indicator light will go out.)

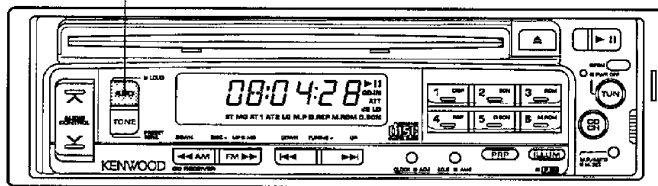

AUTO SEEK TUNING

WHILE LISTENING TO THE TUNER

- ▶ Press the Tuner button.
(Tuner reception begins.)

1

To select an FM band

- ▶ Briefly press the FM button to choose FM1, FM2 or FM3.

To select an AM band

- ▶ Press the AM button.

F1

FM1

F2

FM2

F3

FM3

A

AM

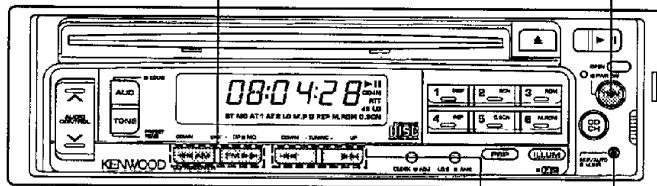

2

- ▶ Press the Auto button to select Auto tuning 1 mode.
(If you see the AT1 display, you are Auto tuning 1 mode.)

F1 92.1
AT1

3

- ▶ Press either the Down seek or the Up seek button.
(The Auto seek function will find the next station you can receive.)



DOWN SEEK UP SEEK

F1 92.1
ST AT1

Display shows frequency of station received.

Illuminated when FM stereo broadcasts are received.

MANUAL TUNING

WHILE LISTENING TO THE TUNER

- ▶ Press the Tuner button.
(Tuner reception begins.)

1

To select an FM band

- ▶ Briefly press the FM button to choose FM1, FM2 or FM3.

To select an AM band

- ▶ Press the AM button.

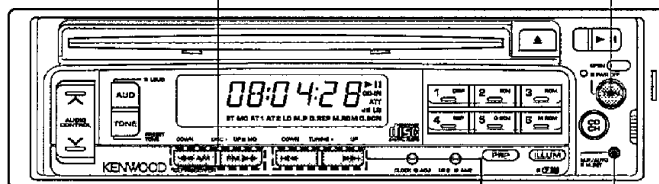
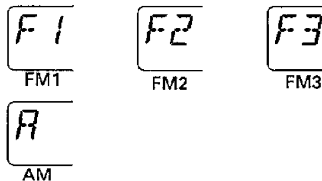

2

- ▶ Press the Auto button to select Manual tuning mode.
(If you do not see the AT1 and AT2 displays, you are in Manual tuning mode.)

F1 92.1

3

- ▶ Press either the down or up arrow buttons.
(The frequency will continue to change as long as you hold the button down.)

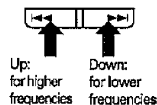

F1 92.1

Display shows frequency of station received.

Illuminated when FM stereo broadcasts are received.

LOCAL SCAN AND MONAURAL TUNING

© 2004 Kenwood Inc.

LOCAL SCAN TUNING

1

To turn on Local scan

- ▶ Briefly press the Local scan button.
(The indicator light will light up.)



2

To turn off Local scan

- ▶ Briefly press the Local scan button again.
(The indicator light will go out.)

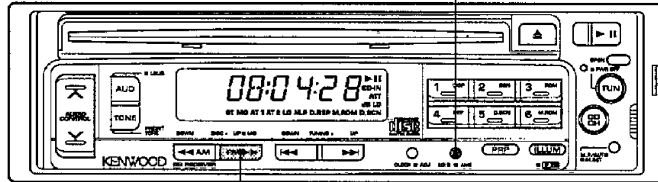

MONAURAL TUNING

1

To turn on Monaural tuning

- ▶ Press the Monaural tuning button for more than one second.
(The indicator light will light up.)

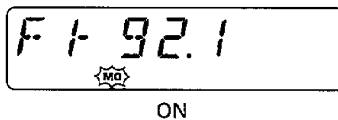

2

To turn off Monaural tuning

- ▶ Press the Monaural tuning button for more than one second.
(The indicator light will go out.)

TO PLAY COMPACT DISCS

TO PLAY

- ▶ Insert a CD with the label side up. (The disc will be drawn in and the CD-IN and play indicator will appear on the display.)

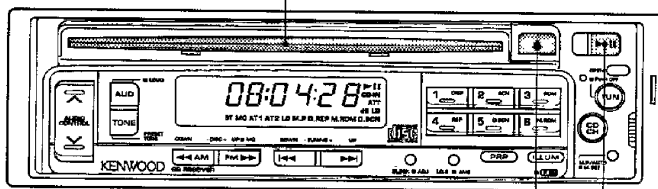
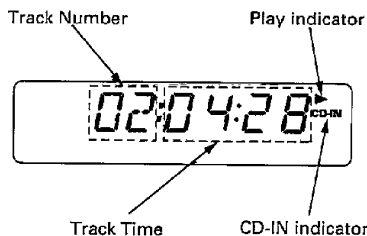
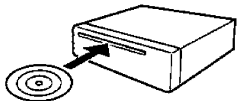

TO STOP AND EJECT

- ▶ Press the Eject button. (The player will eject the disc.)

TO PAUSE

- ▶ Press the Play/Pause button. (The Pause indicator will appear on the display.)
- ▶ To restart play, press the Play/Pause button again.

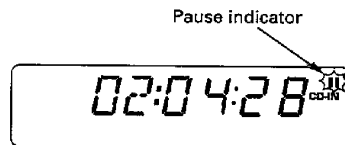

NOTE

- If you press the Play/Pause button before a disc that has been ejected is removed from the disc slot, it will be drawn back into the player and played, automatically.
- To protect your discs, the player automatically draws in any disc that has been ejected but not removed within 15 seconds.
- Do not attempt to insert a disc in a slot where there is already another disc.

SKIP AHEAD/SKIP BACK

Operation	Press
Skip Ahead	▶▶
Skip Back	◀◀

The action will stop when you release the button.

TIME DISPLAY

- ▶ Each time you press the Display button, the display switches between current track and total CD playback time.
(The "+" indicates total CD playback time.)

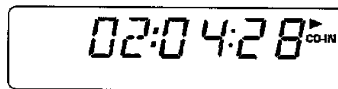

Current track playback time display

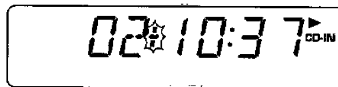

Total CD playback time display

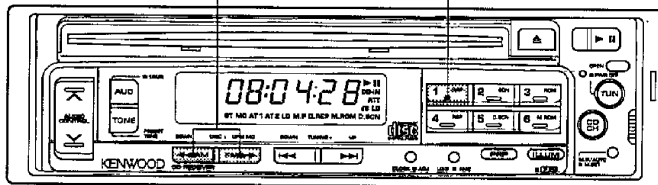

⚠ CAUTION

- This unit is designed for playing 12cm(5in.) compact discs. Attempting to play 8cm(3in.) discs may damage the unit and should be avoided.

USING THE REMOTE CONTROL

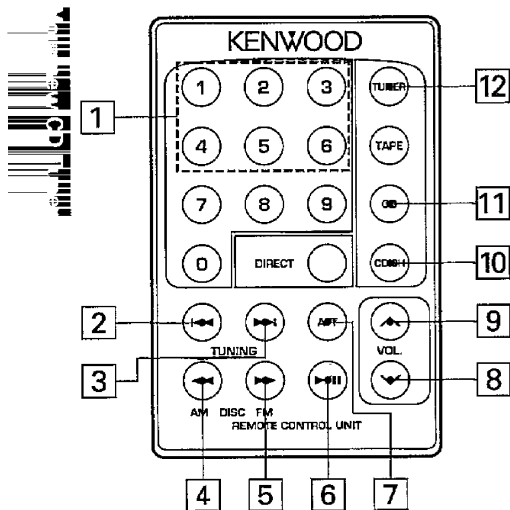

1
TUNER:
Press to select preset stations.

2
CD:
Plays the previous track.
TUNER:
Shifts the lower frequency.
CD CHANGER
Plays the previous track.

3
CD:
Plays the next track.
TUNER:
Shifts to higher frequency.
CD CHANGER:
Plays the next track.

4
CD:
Skip back the CD.
TUNER:
Switches to AM bands.
CD CHANGER:
Plays the previous disc.

5
CD:
Operates in CD Mode.
TUNER:
Operates in Tuner Mode.
CD CHANGER:
Operates in CD Changer Mode.

5
CD:
Skip ahead the CD.
TUNER:
Switches to FM1/FM2/FM3 bands.
CD CHANGER:
Plays the next disc.

6
CD:
Plays or pauses playing of a CD.
CD CHANGER:
Plays or pauses playing of a CD.

7
Lowers audio volume.
To restore previous level
• Press this button again.

8
Lowers volume.

9
Increases volume.

10
Press for CD changer mode.

11
Press for CD mode.

12
Press for Tuner mode.

NOTE

Before using this unit for the first time, pull out the tape from the battery box.

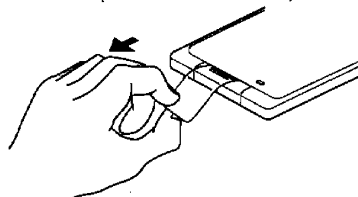

PRESET STATIONS

1

Select the band and station you want to preset.

2

- ▶ Press the Preset station button you want to use for more than two seconds.
(When the station is entered in memory, the number of the button to which you've assigned it will appear on the display.)

F 1 92.1 1

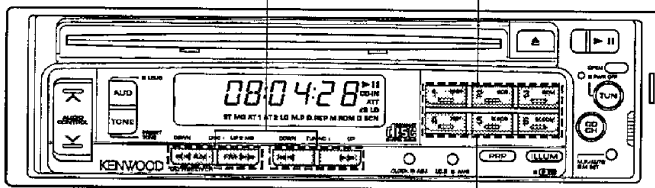

3

By repeating steps 1 and 2 you can preset each button for one station each from the FM1, FM2, FM3 and AM bands.

4 USING PRESET STATIONS

- ▶ Briefly press the button of the station you want.
(When you press the button, you will hear the station assigned to it.)

F 1 92.1 1

NOTE

- When you assign a preset station to a button, the previous setting will be erased.

AUTO MEMORY

1

To select an FM band

- ▶ Briefly press the FM button to choose FM1, FM2 or FM3.

To select an AM band

- ▶ Press the AM button.

F1
FM1

F2
FM2

F3
FM3

A
AM

2

- ▶ Press the Auto memory button for more than two seconds. (When the seek function finds a station, the "A" indicator will light up. The display will show the number of the button to which it has been assigned.)

F1 92.1 A

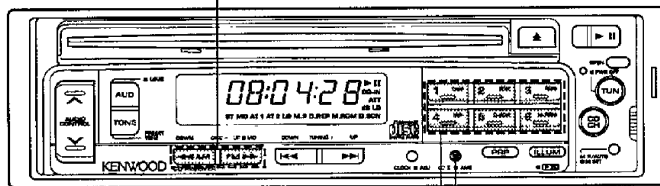

3

When six stations have been found, the Auto memory function stops. You will hear the last station selected.

4 USING PRESET STATIONS

- ▶ Briefly press the button of the station you want. (When you press the button, you will hear the station assigned to it.)

F1 92.1 1

PRESET SEEK

1

Store a station frequency for each Preset button.

2

- ▶ Press the Auto button to select Auto tuning 2 mode.
(If you see the AT2 display, you are in Auto tuning 2 mode.)

F 1 - 92.1 - 1
AT2

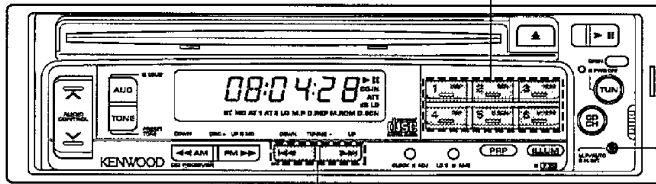

3

Down preset seek

- ▶ Press the ◀◀ button.
(The station stored in the previous Preset button is received and the button number is displayed.)

Up preset seek

- ▶ Press the ▶▶ button.
(The station stored in the next Preset button is received and the button number is displayed.)

PRIORITY PRESET

► Press the Priority preset button.
(As soon as reception begins.)

TO TURN IT OFF

► Press the Priority preset button
again.
(The tuner will return to the previous
mode.)

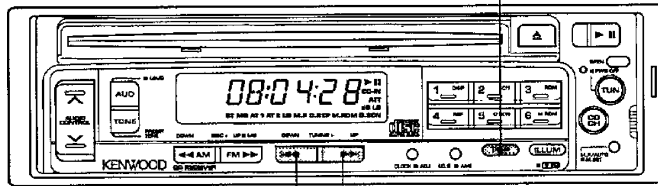

TO CHANGE THE PRIORITY PRESET

► Press the Priority preset button
and tune to the station you want.
(The next time you press Priority
preset, the tuner will shift to this
station automatically.)

NOTE

- Only seek and manual tuning can be used in Priority preset mode.

DIRECT ACCESS TUNING

1 Select either AM or FM

- ▶ To select AM, press the AM button.
- ▶ To select FM, press the FM button.

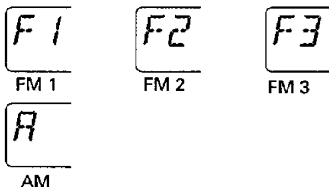

2 Select direct access

- ▶ Press the Direct button.
(The 1888 will appear on the display and blink for 10 seconds.)



3 Enter a new frequency

- ▶ Before the frequency indicator stops blinking, use the number keys control to enter the frequency you prefer.
For example: To enter FM 87.9 MHz, press 8, 7, 9.
For example: To enter AM 1160 kHz, press 1, 1, 6, 0.

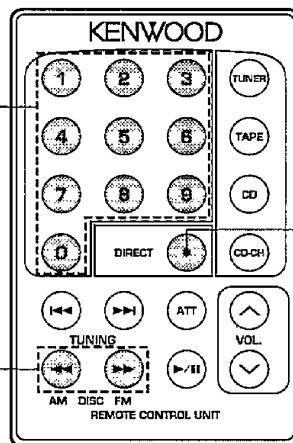

NOTE

- You cannot enter frequencies your tuner cannot receive.

TRACK SEARCH

BACKWARD TRACK SEARCH

- ▶ Briefly press the ◀◀ button until you see the number of the track you want to play. The unit will begin playing the track shown on the display.



Track No.

FORWARD TRACK SEARCH

- ▶ Briefly press the ▶▶ button until you see the number of the track you want to play. The unit will begin playing the track shown on the display.

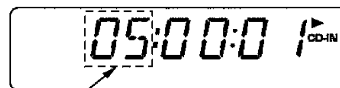

Track No.

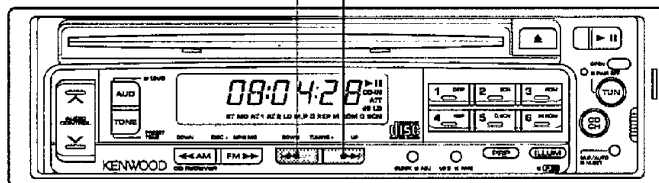

TRACK REPEAT

1

- ▶ To repeat the track you are listening to, press the Track repeat button.
(The Repeat indicator will appear on the display.)

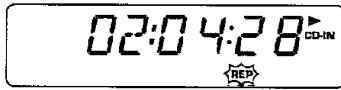

ON

2

- The player will repeat the track you are playing.

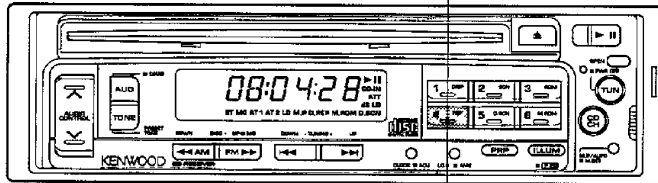

TO STOP

- ▶ Press the Track repeat button again.
(The Repeat indicator will disappear.)



TRACK SCAN

1

- ▶ Press the Track scan button.

2

The player will play the first 10 seconds of each track. The track number will flash on the display.

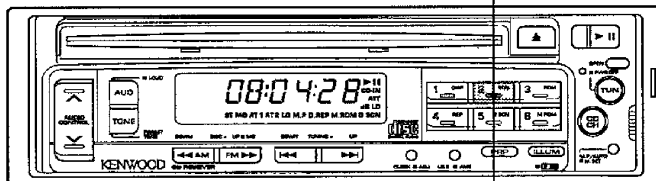
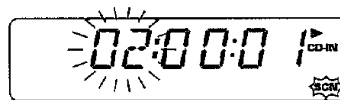

3

- ▶ To select a track, press the Track scan button again. (Scanning will stop and playback begin.)

RANDOM PLAY

1

▶ Press the Random button.
(The Random indicator will light up, and the player will randomly select another track from the disc you are playing. The track numbers on the display will change continuously.)



During random search

2

When the track is selected, playback will begin automatically.

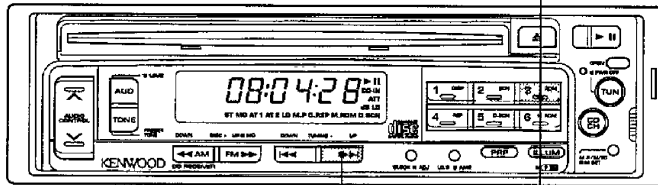

3 TO SELECT ANOTHER TRACK

▶ Press the **SKIP** button.
(The player will randomly choose another track.)

TO STOP

▶ Press the Random button again.
(The disc play returns to normal.)

Kenwood
© 2000 Kenwood Inc.

DIRECT TRACK/DISC SEARCH

■ DIRECT TRACK SEARCH

1

- ▶ Use the number keys to enter the number of the track you want.

(When the player reaches the track you've selected, its number will blink for 10 seconds.)

For example: To listen to track number 7,
press ⑦.
To listen to track number 12,
press ①, ②.

2

- ▶ To skip forward or backward, press the ►► or ◀◀ buttons.

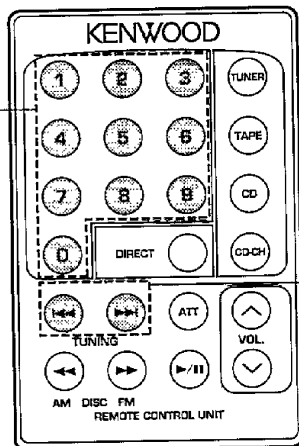

TO PLAY COMPACT DISCS

TO START

- ▶ Press the CD changer button.
(The disc starts playing.)

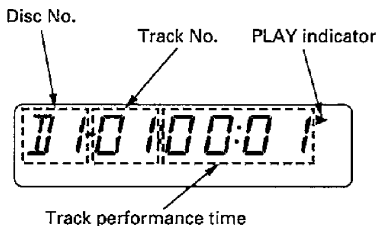

TO SKIP AHEAD/BACK

Operation	Press
Ahead	▶▶
Back	◀◀

Hold down the button until you reach the track you want.

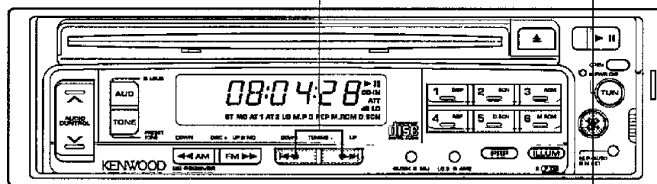

TO STOP

- ▶ Press the CD changer button again.
(The disc will stop playing.)

NOTE

- When the player reaches the end of the last track on the disc you are playing, it will shift automatically to the first track on the next disc in order.
- When you change the discs in the autochanger, the Load indicator will appear on the display.
- "0" indicates the No. 10 disc.

TRACK/DISC SEARCH

BACKWARD TRACK SEARCH

- ▶ Briefly press the **◀◀** button until you see the number of the track you want to play. The unit will begin playing the track shown on the display.

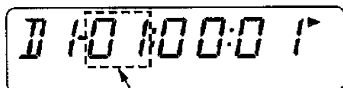

Track No. display

FORWARD TRACK SEARCH

- ▶ Briefly press the **▶▶** button until you see the number of the track you want to play. The unit will begin playing the track shown on the display.

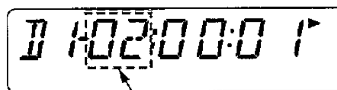

Track No. display

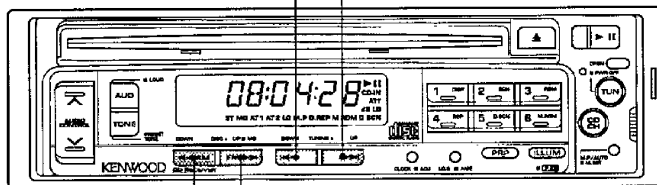

BACKWARD DISC SEARCH

- ▶ Press the **Disc-** button until you see the number of the disc you want to play. The unit will begin playing the disc shown on the display.

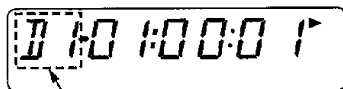

Disc No. display

FORWARD DISC SEARCH

- ▶ Press the **Disc+** button until you see the number of the disc you want to play. The unit will begin playing the disc shown on the display.

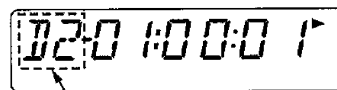

Disc No. display

NOTE

- If you try Backward track search while playing track No. 1, the player will resume play at the start of track No. 1.
- If you try Forward track search while playing the last track on a disc, nothing will happen.

TRACK/DISC REPEAT

TO START TRACK REPEAT

- ▶ Press the Repeat button.
(The Repeat indicator will appear on the display, and the player will repeat the track you are playing until you cancel repeat.)

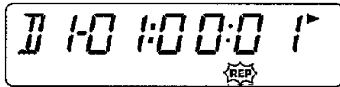

Track repeat ON

TO START DISC REPEAT

- ▶ Press the Repeat button twice.
(To use Track repeat function, press the Repeat button once.)
(The Disc repeat indicator will appear on the display, and the player will repeat the disc you are playing until you cancel repeat.)

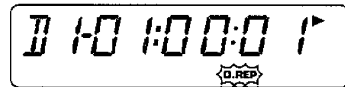

Disc repeat ON

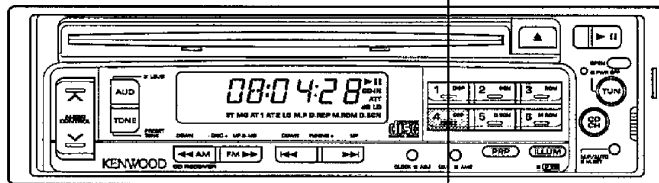

TO STOP

- ▶ Press the Repeat button again.
(To use Track repeat function, press the Repeat button twice.
To use Disc repeat function, press the Repeat button once.)
(The Disc repeat indicator will disappear.)

TRACK SCAN

1

▶ Press the Track scan button.

2

The player will play the first 10 seconds of each track. The track number will flash on the display.



ON

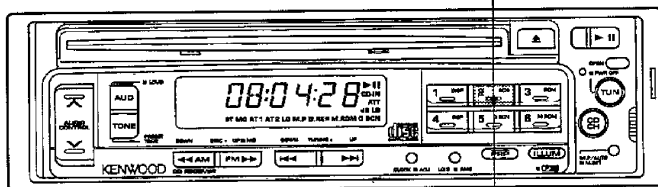

3

▶ To select a track, press the Track scan button again.
(Scanning will stop and playback begin.)

©2004 Kenwood North America, Inc.

1

▶ Press the Disc scan button.

2

The player will play the first 10 seconds from each disc in the changer. The disc number will flash on the display.

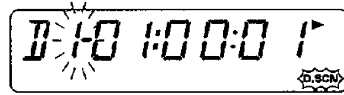

ON

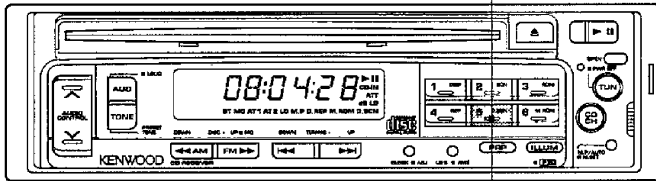

3

▶ To select a disc, press the Disc scan button again. (Scanning will stop and playback begin.)

RANDOM PLAY

1

▶ Press the Random button.
(The player will randomly select another track from the disc you are playing. The track numbers on the display will change continuously.)



During random search

2

When the track is selected, playback will begin automatically.

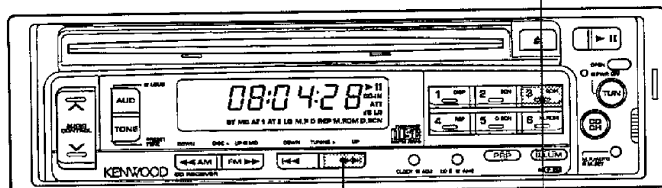
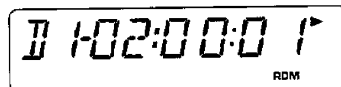

3 TO SELECT ANOTHER TRACK

▶ Press the ►►► button.
(The player will randomly choose another track.)

TO STOP

▶ Press the Random button again.
(The disc play returns to normal.)

NOTE

- When all the tracks on a disc have been played, the player will randomly select the next disc.

MAGAZINE RANDOM PLAY

1

- ▶ Press the Magazine random button.

(The Magazine random indicator will light up, and the player will randomly select a disc and track from the magazine in the changer. The track numbers and disc numbers on the display will change continuously.)

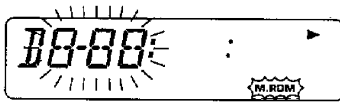

During magazine random search

2

- When the search is complete, playback will begin automatically.

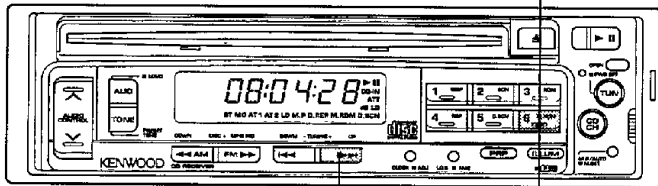

3 TO SELECT ANOTHER TRACK

- ▶ Press the **▶▶▶** button.
(The player will randomly choose another disc and track.)

TO STOP

- ▶ Press the Magazine random button again.
(The disc play returns to normal.)

NOTE

- This function is not available if you use the KDC-C100/C200/C300/C400/C301/C401 as the CD auto changer.

MEMORY PLAY

Example: To store track No. 6 on disc No. 8 in memory and play it with memory play.

1 Enter CD Memory mode

- ▶ Press the Memory Play button for more than 1 second. (The unit enters the CD memory mode, and the memory No. available for storage appears blinking on the display.)

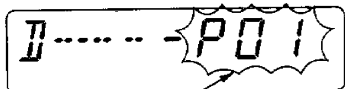

Memory No.

2 Select the disc

- ▶ Enter "8" with the numeric key. (Disc No. 8 is selected, and "8" appears on the disc No. display.)

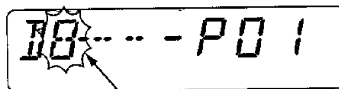

Disc No. display

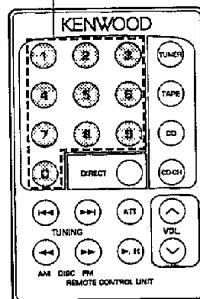
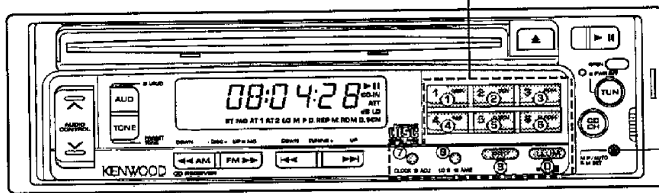

5

Up to 20 tracks can be stored by repeating steps 1 to 4 for each of them.

6 Cancel CD memory mode

- ▶ Press the Memory Play button. (The CD memory mode is released.) The CD memory mode is also canceled automatically when no operation has been done for more than 10 seconds.

NOTE

- Enter "0" to select disc No. 10.
- To change the content of memory, display the memory No. to be changed by pressing the **◀◀** or **▶▶** button before step 2, and enter new disc and track Nos. by proceeding to steps 2 to 4.
- The memory content can be cleared by entering "0" as the disc No. and "00" as the track No.

3 Select the track

- ▶ Enter "0" then "6" with the numeric keys.
(Track No. 6 is selected, and "06" appears on the track No. display.)

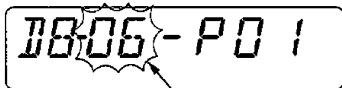

Track No. display

4 Store it in memory

- ▶ Briefly press the Memory Play button.
(The selected disc and track Nos. are stored in memory, and the next memory No. available for storage appears.)

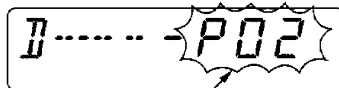

Memory No.

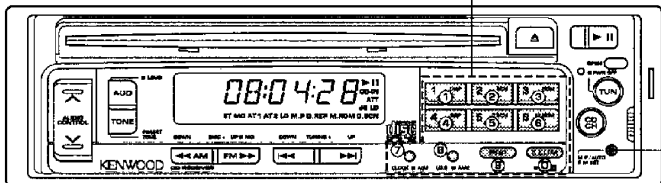
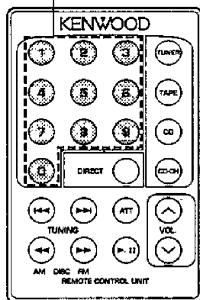

7 Start Memory Play

- ▶ Briefly press the Memory Play button.
(The M.P. indicator lights up and the stored tracks will be played in the order they were stored in memory.)



ON

To play the track of the next memory No.:
Briefly press the ►► button.

To play the track of the previous memory No.:
Briefly press the ◄◄ button.

- ▶ To stop memory play, briefly press the Memory Button again.

Note:
The memory play should be started after canceling the CD memory play mode.

NOTE

- When the memory play is restarted after it has been stopped, it can be resumed from the memory No. where it was stopped.
- The direct track/disc search functions are not available during memory play.

DIRECT TRACK/DISC SEARCH

■ DIRECT TRACK SEARCH

1

- ▶ Use the number keys to enter the number of the track you want.

(When the player reaches the track you've selected, its number will blink for 10 seconds.)

For example: To listen to track number 7, press 7.
To listen to track number 12, press 1, 2.

2

- ▶ To skip forward or backward, press the ►► or ◀◀ buttons.

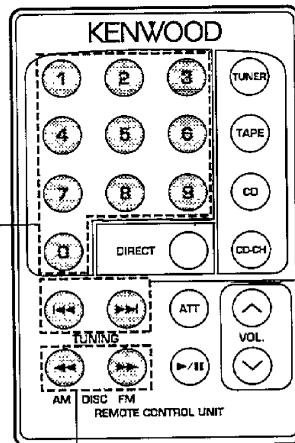

■ DIRECT DISC SEARCH

1

- ▶ Use the number keys to enter the number of the disc you want.

(When the player reaches the disc you've selected, its number will blink for 10 seconds.)

For example: To listen to disc number 5, press 5.
To listen to disc number 10, press 1, 0.

2

- ▶ To skip forward or backward, press the ►► or ◀◀ buttons.

CLOCK DISPLAYS/SETTING

■ Displays change like this

- ▶ Pressing the Clock button changes displays as indicated to the right.

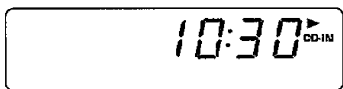

Clock indication

Time	Displays
Tuner	Frequency ↔ Time
CD play	Track No./Track Time ↔ Time
CD changer play	CD No./Track No./Track Time ↔ Time
All Mode Standby	"OFF" ↔ Time

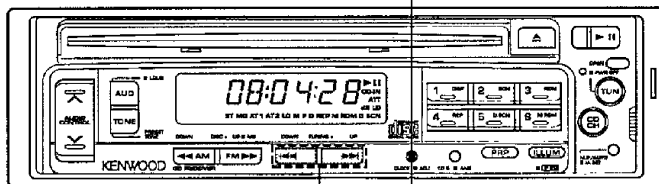

■ To set the clock

1

- ▶ Start with the unit's display showing the time. Press the Clock button.

2

- ▶ While holding down the Clock button, press **◀◀** to change the hour and **▶▶** to change the minute.

AUDIO CONTROLS

1

- ▶ To select Bass, Mid-bass, Treble, Balance, Fader, or return to volume, briefly press the Audio button until the function indicator appears on the display.

2

- ▶ Use the control button to adjust the level of the function you've chosen (For details, see the table on page 41).

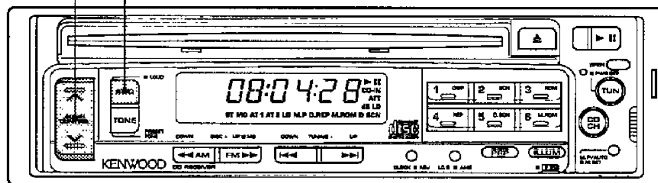

PLEASE OBSERVE

After five seconds, the controller will return automatically to the Volume setting.

NOTE

- This unit allows the Tone (Bass, Mid-Bass and Treble) control to be set independently for Tuner, CD and CD Auto Changer modes. The Tone settings will change automatically whenever you change from one mode to another.

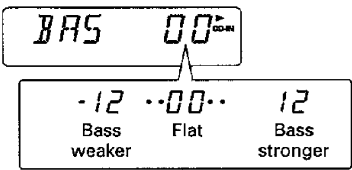
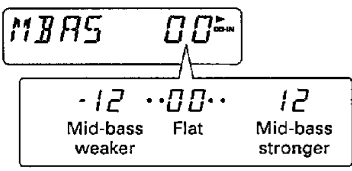
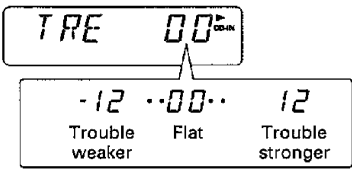
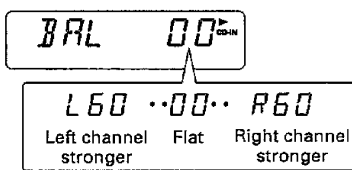
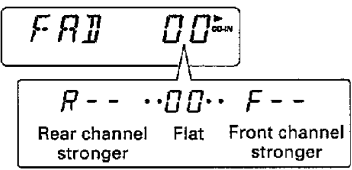
Display	Audio Control Operation	
	Press the ∇ button	Press the \blacktriangle button
<p>To adjust bass</p> 	Bass weaker	Bass stronger
<p>To adjust mid-bass</p> 	Mid-bass weaker	Mid-bass stronger
<p>To adjust treble</p> 	Treble weaker	Treble stronger
<p>To adjust right/left channel balance</p> 	Left channel stronger	Right channel stronger
<p>To adjust front/rear balance</p> 	Rear channel stronger	Front channel stronger

SOUND FIELD EXPANSION

PRESET TONE

Example: To set Bass to 4 dB, Mid-Bass to -2 dB and Treble to 6 dB, store these tone settings in memory under preset button No. 2 and recall them for later use.

1 Enter Preset Tone mode

- ▶ Press the Preset Tone button. (The unit enters the preset tone mode.)
The preset tone mode is canceled automatically if no operation has been done for more than 5 seconds. Therefore, be sure to proceed to each operation step within 5 seconds after the previous step.

2 Adjust Bass

- ▶ Press the Audio button to select the bass adjustment mode. (The bass adjustment mode is indicated by the blinking of the bass level indicator.)
- ▶ Set the bass level indicator to "4" by pressing the ∇/Δ buttons. (The bass level is set to 4 dB.)

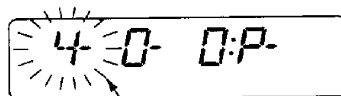

Bass level indicator

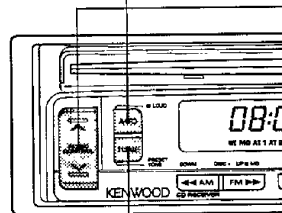

5 Store tone settings in memory

- ▶ Press the hold preset button No. 2 for more than 2 seconds. ("P-2" is displayed when the settings have been stored in memory.)

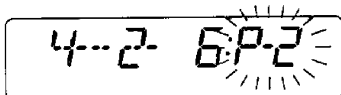

6 Recall tone settings

- ▶ While in the preset tone mode, press Preset button No. 2. ("P-2" is displayed, and the stored tone settings are recalled.)

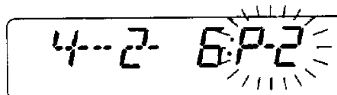

3 Adjust Mid-bass

- ▶ Press the Audio button to select the mid-bass adjustment mode. (The mid-bass adjustment mode is indicated by the blinking of the mid-bass level indicator.)
- ▶ Set the mid-bass level indicator to “-2” by pressing the ∇/\wedge buttons. (The mid-bass level is set to -2 dB.)

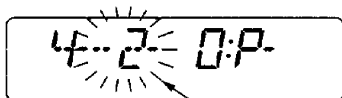

Mid-bass level indicator

4 Adjust Treble

- ▶ Press the Audio button to select the treble adjustment mode. (The treble adjustment mode is indicated by the blinking of the treble level indicator.)
- ▶ Set the treble level indicator to “6” by pressing the ∇/\wedge buttons. (The treble level is set to 6 dB.)



Treble level indicator

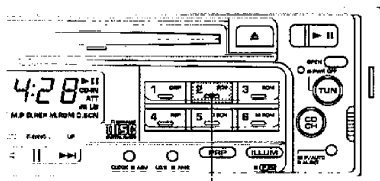

To cancel preset tone mode

To cancel the preset tone mode, press the Preset Tone button. The preset tone mode is also canceled automatically when no operation has been done for more than 5 seconds.

Every time steps 2 to 5 above is repeated, a combination of tone settings can be stored under each of preset buttons Nos. 1 to 6.

SELECTABLE ILLUMINATION

- ▶ Briefly press the Illumination button.
(The illumination will change from green to orange or vice-versa.)

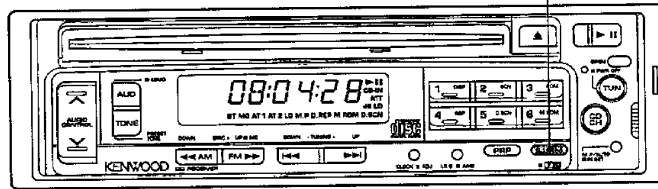

SELECTABLE DISPLAY TYPE

- ▶ Press the Positive/Negative button for more than one second. (The display will change from negative to positive or vice-versa.)

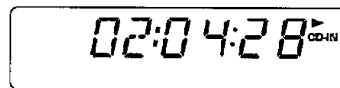

Positive



Negative

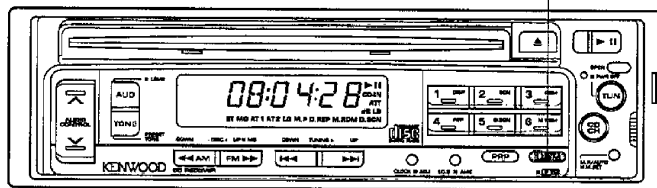

NOTE

- If the light switch of the car is turned ON after connecting the auto illumination control lead and setting the display to negative type and turning the unit OFF, the positive type display appears.



PHONE INTERFACE

1

Connect the phone interface lead (See. p. 50).

2

When a telephone call is received, the display shows **CALL**, and the current function pauses.

CALL

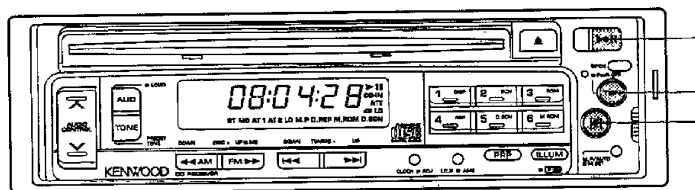

3

▶ To resume use of the previous function, restart by pressing any other button.
(The Call indicator will disappear.)

NOTE

- This function does not start operating for 10 seconds after turning the ignition ON.

THEFT DETERRENT FACEPLATE

■ To remove the faceplate

1

Press the Open button to unlock the faceplate, then remove carefully.

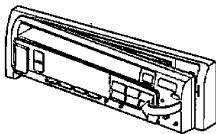

2

Place the faceplate in the storage case with the button side facing up.

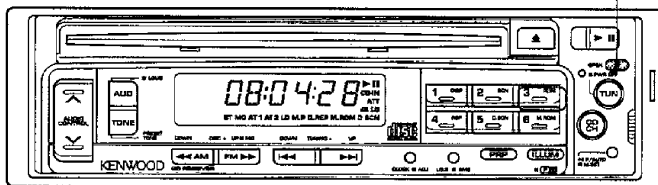
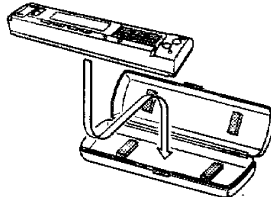

■ To install the faceplate

1

Align the projections on the faceplate mount with the grooves on the left side of the faceplate.

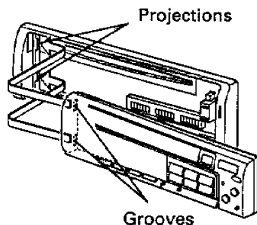

2

Press on the right side of the faceplate until it locks in place.

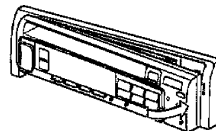

NOTE

Disabled system indicator

- To deter theft, this unit is equipped with a Disabled system indicator. It can be turned ON and OFF by holding down preset station buttons "1" and "3" while turning the power on.

CHANNEL BAND SELECTION

1

Turn power OFF.

2

- ▶ Hold down preset station buttons "1" and "5".
- ▶ Turn power ON.
(The bands will change to 50kHz for FM and 9kHz for AM.)

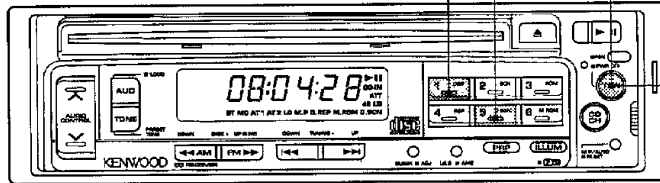



3

Repeating steps 1 and 2 will change the bands back to 200kHz for FM and 10kHz for AM.

NOTE

- When the bands are changed, all memory settings will be erased.
- This feature is not used in the United States and Canada.

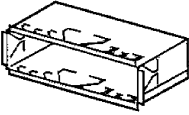
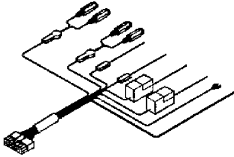
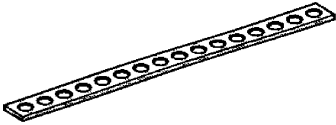
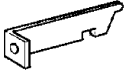
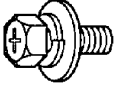
ACCESSORIES

Part Name	External View	Number of Items
Mounting case		1
Power cord		1
Metal mounting strap		1
Removal tool		1
Assembly screw with washer (M4 × 8)		1
Machine screw (M5 × 6)		4

INSTALLATION PROCEDURE

1. Before starting installation, disconnect the negative (-) terminal of the battery. This will prevent short circuits.
2. Connect the Input and Output leads (see p.51).
3. Connect the Ground lead (Black) to the metal body of the car. (see p.51).
4. Connect the Memory backup lead (Yellow) (see p.51).
5. Connect the Power supply lead (Red) (see p.51).
6. Install the Mounting Sleeve (see p.52).
7. Connect the negative (-) terminal of the battery.
8. Press the Reset button.

▲ CAUTION

- A short circuit may cause a blown fuse. A short circuit is a serious problem that could also cause a fire. Check the wiring carefully and, if any wires are short-circuited, rewire immediately. If no short-circuits are found, replace the fuse with one having the same rating (see indication in fuse box).
- Check that no unconnected wires or connectors are in contact with the body of the car. Extraneous noise or current entering the system can cause malfunction or damage.

■ Installation Angle

This unit must be installed at an angle of less than 30° from the horizontal.

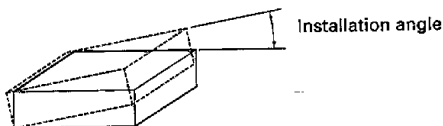

■ Example of telephone interface connection

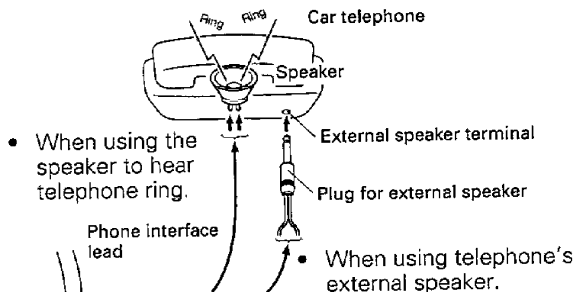

NOTE

*Be sure to use a shielded cable.

- Do not ground to chassis at a shielded part.

CONNECTIONS

* Circled numbers indicate the procedures described on page 50.

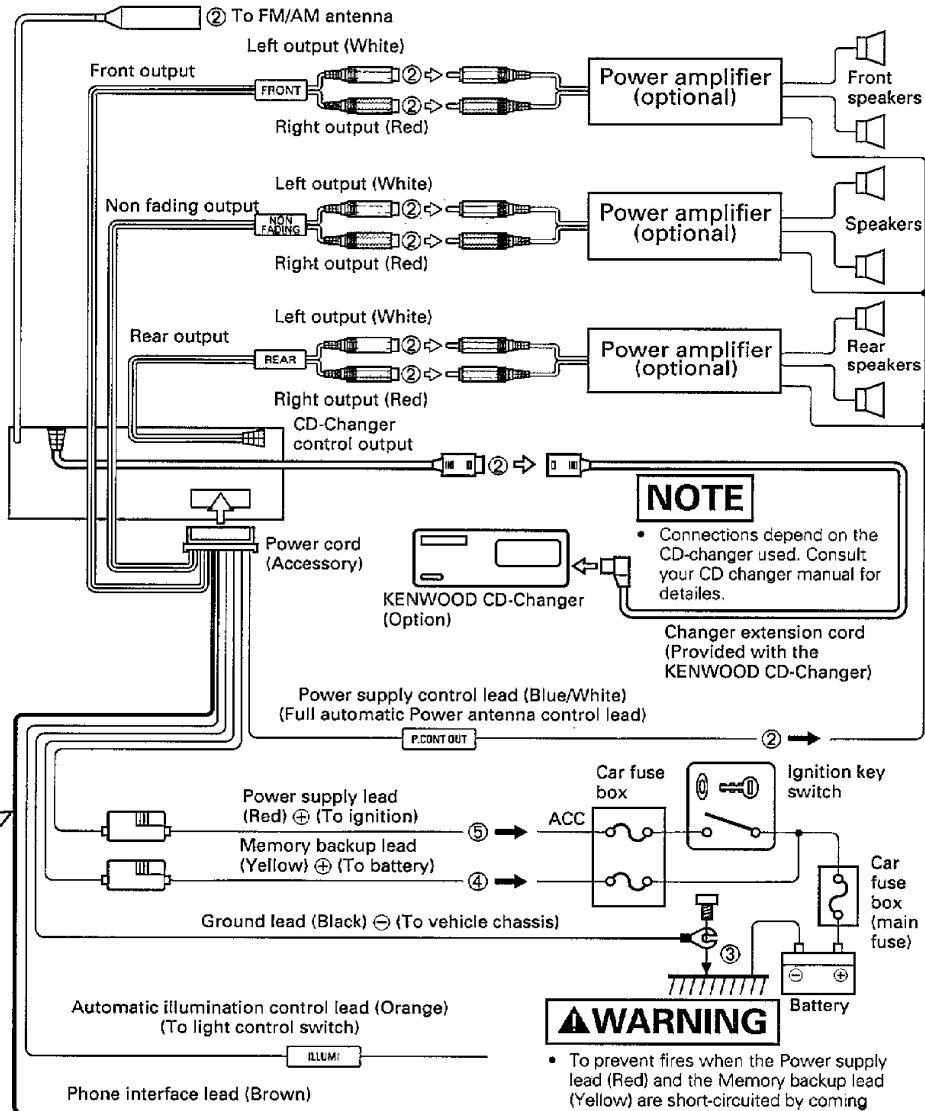

(Connect to the plus ⊕ or minus ⊖ terminal of the telephone speaker or buzzer, or to the head phone jack or speaker terminals.)

INSTALLATION

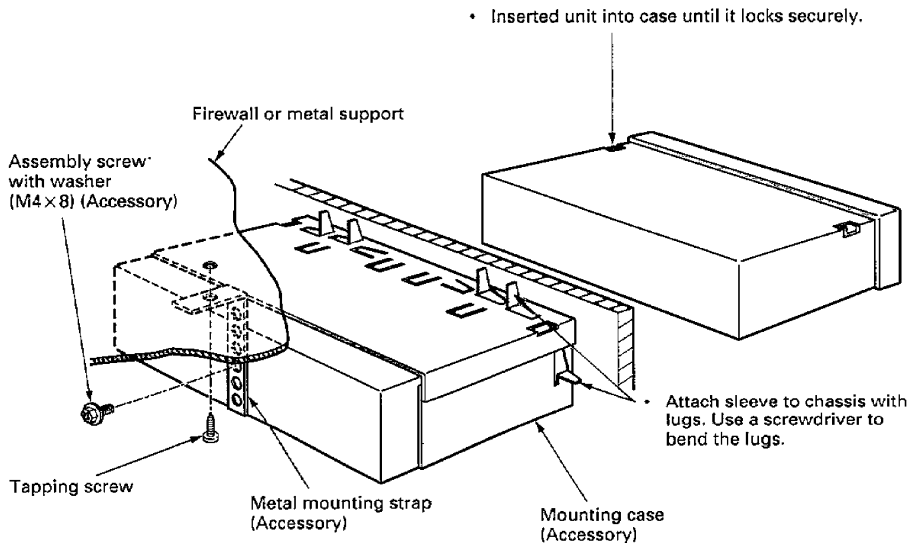

NOTE

- Securely install the unit. If the case is not installed correctly, the sound may be skipped.
- When installing in some cars made in Japan, insert Machine screws (M5 x 6) (Accessory) into 2 of the holes indicated below.

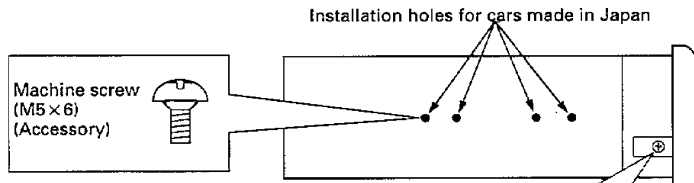

CAUTION

After removing the panel, be sure to re-install this screw.

■ To remove the unit

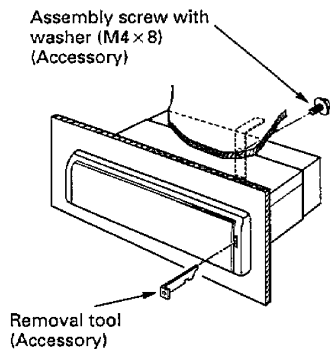

1. Remove the assembly screw and washer holding on the back panel. Then insert removal tool into slot.

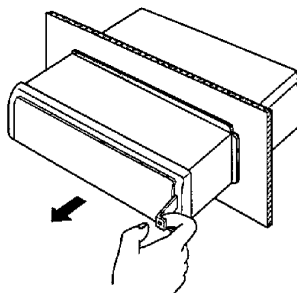

2. Use the removal tool to pull out the unit.

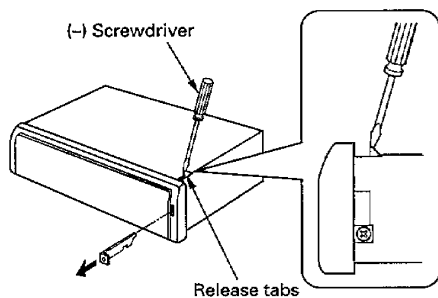

3. While using a screwdriver to press down the release tabs on the side of the chassis, pull out the removal tool.

TROUBLESHOOTING GUIDE

Often, what appears to be a malfunction is due to user error. Before calling for service, please consult the following table.

Symptom	Cause	Remedy
Compact disc cannot be inserted.	A compact disc has already been inserted and you are trying to insert another disc.	Eject the previously inserted disc and insert another one.
A disc is ejected immediately after being inserted.	<ol style="list-style-type: none">1. The compact disc is inserted upside down.2. The compact disc is very dirty.	<ol style="list-style-type: none">1. Insert the disc with the labeled side facing up.2. Clean the disc (refer to "Cleaning your discs").
Even when the required track is specified, the specified track is not played or the player does not function.	The player is set to RANDOM PLAY.	Release RANDOM PLAY.
Sound is skipped by vibrations.	<ol style="list-style-type: none">1. The compact disc is dirty or damaged.2. The unit is not installed securely.	<ol style="list-style-type: none">1. If the sound skips even while the car is stationary, clean the compact disc (refer to "Cleaning your discs").2. Install the unit securely.
The sound quality is poor due to noise during playback.	<ol style="list-style-type: none">1. The compact disc is damaged or dirty.2. The sound recorded in the compact disc itself is poor.	<ol style="list-style-type: none">1. Clean the compact disc (refer to "Cleaning your discs").2. Try playing another compact disc. If its sound quality is good, the poor sound was due to the disc itself.
No sound one channel.	The balance/fader control is extremely rotated to one side.	Adjust the balance/fader control.
Poor reception.	The antenna is not extended.	Extend the antenna.
Operation switches do not function.	Correct operation is not obtained due to a sudden change in the power voltage, etc.	Press the Reset button of the front panel.
The phone interface isn't working.	The phone interface lead is not connected properly.	Reconnect it, following the instructions provided.

Symptom	Cause	Remedy
Phone interface signals "CALL" when no call has been received.	The phone interface lead is short-circuited; it may be worn or the cap at the tip may be missing.	Rewire, ensuring that there are no short circuits.
The tuner cannot be operated in the modes other than the Auto seek tuning and the Manual seek tuning.	The tuner is set to the Priority preset mode.	Cancel the Priority preset mode.

■ When the KENWOOD CD Changer is part of your system

Symptom	Cause	Remedy
CD play does not start.	Power button is not set at ON.	Turn power button ON, then press the CD button.
The specified disc is not played; the next disc is played instead.	<ol style="list-style-type: none"> The specified disc is dirty The disc is upside down. Two discs are in the same position. The disc you want is in a different position from that indicated by the number you specify. 	<ol style="list-style-type: none"> Clean the disc. Eject magazine and reinsert disc right side up. Eject magazine and reposition the discs. Eject magazine to check disc and position numbers, then specify again.
No sound is heard even though the changer indicator appears on the display.	<ol style="list-style-type: none"> Volume is set to minimum level. The microprocessor is not operating correctly. The system is not properly connected. 	<ol style="list-style-type: none"> Raise the volume level. Press the Reset button. Check connections and reconnect if necessary.
The specified track is not played.	The player is set to RANDOM PLAY/MEMORY PLAY.	Turn off RANDOM PLAY/MEMORY PLAY.

In some cases, you may see one of the following error messages on your unit's display:

E-01: No disc magazine in changer, or magazine is not inserted properly.

E-02: No discs in disc magazine.

E-04: Disc is too dirty. There is water on the disc. The disc is upside down.

E-05: Memory play switch is passed with no memory.

E-99: Incorrect operation.

⇒ Press the Reset button. If the "E-99" message does not disappear, contact your nearest KENWOOD service agent.

E-0d: When the temperature exceeds 60°C, a protection circuit will stop all operations. This error message will then appear.

⇒ As soon as the space where the changer is located cools off, this message will disappear automatically. If this message appears frequently, you should think about putting the changer in another location.

SPECIFICATIONS

Specification subject to change without notice.

Disc Section

Laser Diode	GaAlAs ($\lambda=780$ nm)
Digital Filter (D/A)	8 Times Over Sampling
D/A Converter	1 bit (with D.P.A.C.)
Spindle Speed	500~200 rpm (CLV)
Wow & Flutter	Below Measurable Limit
Frequency Response (± 1 dB)	5 Hz~20 kHz
Total Harmonic Distortion (1 kHz)	0.005 %
Signal to Noise Ratio	96 dB
Dynamic Range	96 dB
Channel Separation	90 dB
Laser Diode Properties	
Material	GaAlAs
Wavelength	780 nm
Emission Duration	Continuous
Laser Output Power	Less than 44.6 μ W

* This output is the value measured at a distance of 200 mm from the objective lens surface on the Optical Pick-up Block.

FM Tuner Section

Frequency Range	87.9 MHz~107.9 MHz
Channel Space	200 kHz
Usable Sensitivity	12.0 dBf (1.1 μ V/75 Ω)
50 dB Quieting Sensitivity	15.2 dBf (1.6 μ V/75 Ω)
Frequency Response (± 1 dB)	30 Hz~15 kHz
Signal to Noise Ratio (IEC-A)	73 dB
Selectivity (DIN)	70 dB
Capture Ratio	1.5 dB
Stereo Separation (1 kHz)	40 dB

AM Tuner Section

Frequency Range	530 kHz~1700 kHz
Channel Space	10 kHz
Usable Sensitivity	27 dB μ

Audio Section

Tone Action	Bass	± 10 dB (70 Hz)
	Mid-bass	± 10 dB (200 Hz)
	Treble	± 10 dB (10 kHz)
Preout Level (10 k Ω)		1.0 V

General

Operating Voltage	14.4 V (11~16 V)
Current Consumption	5.0 A
Operating Temperature	-10~50 $^{\circ}$ C
Installation Size (W \times H \times D)	182 \times 52 \times 163 mm (7-3/16 \times 2-1/16 \times 6-7/16 in.)
Weight	1.7 kg (3.7 LBs)